

# Scanner Set

## USER MANUAL

**MODEL:PT-30K**

**please read this manual carefully before your install the scanners!**

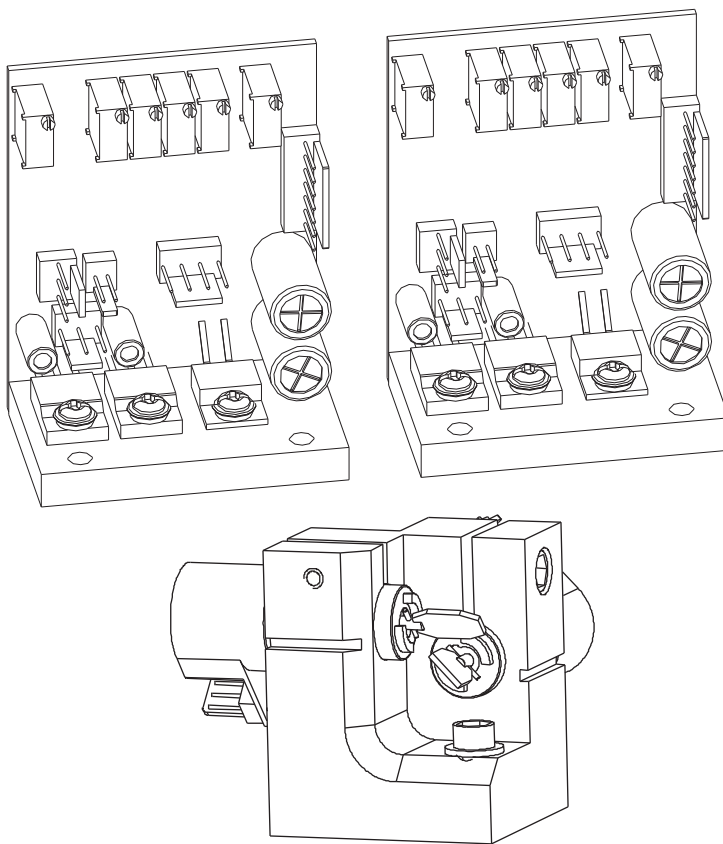

**Thank you very much for choosing our product ,if you have any question,please send email to us.**

Website: [www.spacelas.com](http://www.spacelas.com) Email: [sales@spacelas.com](mailto:sales@spacelas.com)

### Checking Parts

Please make sure the following parts are included:

- 2×Scanners
- 2×Driver board
- 1×Scanner mount
- 1×power supply(PUS)
- 2×Cables driver to scanner
- 2×Cables driver to PUS
- 2×Cables driver to input signals
- 1×User manual

### Introduction

The PT-30K is a fast and versatile galvo scan system, based on moving magnet galvanometers, with a small and rugged dual channel closed loop driver . The system runs at pretty low voltage, and can be implemented in almost any existing or new application. With it's driving speed of up to 50k with the ILDA test pattern, displayed at an angle of 4-5° .

The standard delivery package contains driver , power supply and input cable .The driver is presetted to the included galvos, but has to be retuned slightly before first use. This can be done by using the three adjustment trimmers on the driercard. Please note, that the galvos are not set for maximum speed at small scan angle, but set to a usable angle of 20° at 30Kpps.

### The cable

High speed galvanometers demand for special cables, which are shielded an separated between motor and position detector. Cable lengths up to 100cm are allowed. We recommend a cable length of maximum 50cm.

### Power source

Power source is not very critical and has minor influence on speed and quality of the complete scanner system .Even if a standard transformer with a bridge and caps will do, We recommends a stabilized or switched power supply. The driver board is able to run between +/- 24VDC to +/-28VDC, at 1A each. Recommended power supply is the PSU with 2x24VDC.

If you use transformer and bridge, then make sure to have minimum 10,000 uF caps per voltage, better 40,000 uF, parallel with a 100uF for fast peaks. Do not use extra capacitors at switching power supplies.

***Polarity of connecting power to the driver is important. No warranty if connected incorrect.***

### The measuring procedure

The PT-30K was measured with Mamba Black with USB-Box, running at the desired output speed, using the standard ILDA test pattern. Laboratory power supply at +/-24VDC, room temperature. Windows PC with Mamba Black , 12/30k ILDA testframe. It was also tested afterwards with pangolin LD2000, running the same test pattern. 5x10x0.7mm mirror was used during measuring period. Tests showed a slight decrease of performance at about 5 % by using a larger 6x11x0.7mm mirror. The galvos where fixed in the standard mounts on an aluminum baseplate, no forced cooling.

**The ILDA standard**

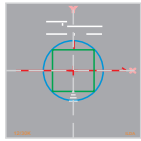

Driver is set too fast or output speed of computer is too slow . The inner circle is larger than the green square .

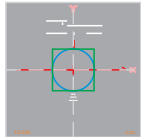

Driver and output speed matches together .

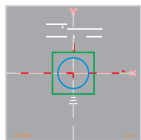

Driver is too slow or output speed of computer is too high . Readjust driver or slow down computer .

Deflection angle	Operating voltage	Speed
20° optical deflection	+/-24V	>30.000 pps
15° optical deflection	+/-24V	>32.000 pps
10° optical deflection	+/-24V	>35.000 pps
8° optical deflection	+/-24V	>40.000 pps
5° optical deflection	+/-24V	>50.000 pps

**Adjustments**

Standard configuration shows 7 adjustment pots , 4 of them are necessary for the user . 3 of them should not be changed in setting . These are necessary for linearity and other galvo specific settings .

**Basic adjustments**

The driver board comes already pre adjusted for 30° projection angle and needs to be set up for the galvo only in small areas. Every galvo is different, so 3 of them adjustments are needed. For this, the ILDA test pattern is used ,also a setup of the galvos in XY with a laser . If you need to ture the driver faster to smaller angles, follow the procedure below . Also if the driver is totally deadjusted , this will be the procedure to retune it :

- Size, Servo-Gain, Damping und HF-Damping are adjusted counter clockwise to their left zero position. Now turn LFD 5 full rounds clockwise to right.
- Connect computer with ILDA test pattern, run it at approx. 20kpps.
- Power on the amplifiers.
- Slowly open the servo gain (clockwise). The mirror of the galvo should move now to its middle position. If yes, turn two rounds clockwise.
- Slowly open the size until you see the galvo moving.
- Increase servo gain until you see overshoots. Correct it with LFD.
- Decrease undershoots by opening the HFD pot slightly clockwise. Remove gain/LFD procedure and correct with HFD, until you the picture looks satisfying. Carefully fine tune the driver. The better your fine tuning is, the faster is the scanspeed.
- Increase speed of test patterns and readjust for optimized picture.

### In / Outputs

On each pin connector, all necessary in and outputs are available. Here is the power supply connected, We recommend a ground free operation between computer and drivers.

### Important hints

- Do not remove the driver board from its mounting bracket. This additional metal plate is needed for ground and increases stability of the driver. The bracket is isolated from ground.
- Do not use cheap and unshielded cable. We recommend to use the phenix technology only with phenix technology cables. These cables are tested and designed for this driver. We do not offer any warranty, if other cables are used.
- If the galvos gets very hot (above 45°C/115° F), switch off the system and check for errors of problems. Use appropriate heatsink for the galvos. Do NOT run them without heatsink!!
- If the fuses blow continuously, do not replace them with a higher value. Check for possible errors.
- The maximum current per phase should be in average below 700mA. If it is higher, there can be a problem, which can result in overheating the galvos.

### Connecting the dual channel driver

Each channel of the driver must be connected to the power supply and to the signal source. Both 4pin connectors show equal pinning. Connect both channels +24VDC to the positive 24VDC coming from the power supply, also the -24VDC to the negative source from the power supply. Use only one ground pin of each connector to connect to the GND of power supply.

### PIN Layout Switch Power Supply

Input 100-260 VAC, I<sub>max</sub> 1A

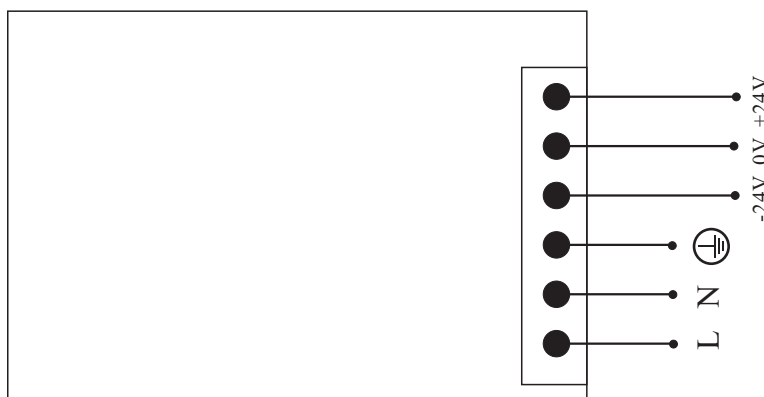

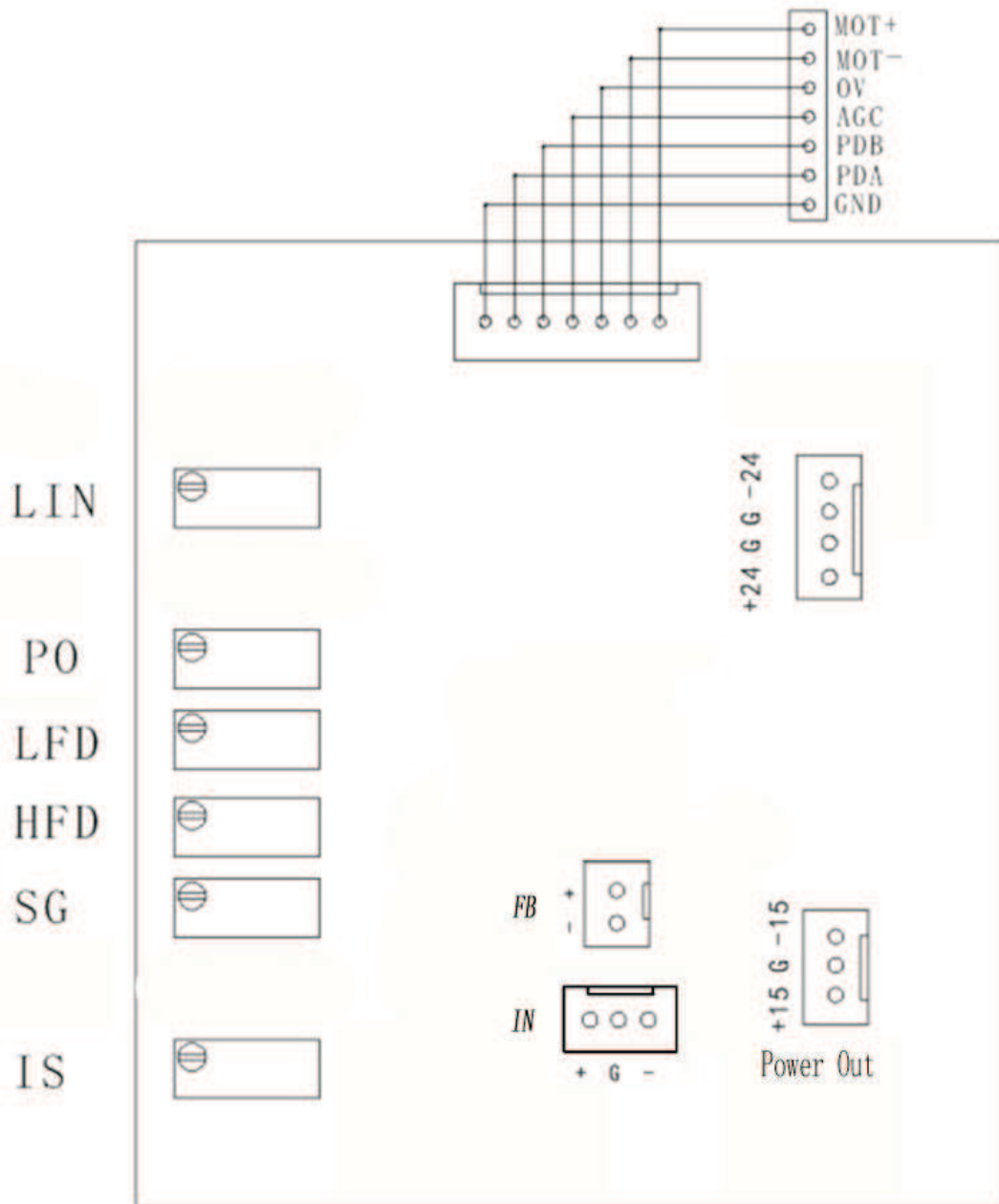

**Legend:**

- Offset: Electrical offset of the driver, not the galvo! Is adjusted in factory.
- HFD: HighFrequency Damping. Corrects undershoots
- LFD: LowFrequency Damping Corrects overshoots.
- Servo: Servo-Gain. Power of the feedback signal for the internal PID controller.
- Size: Increases or decreases input sensitivity of the complete driver. Does not change driver settings.
- Position Scale:factory Setting.
- Linearity:factory Setting.

Scanner Mount

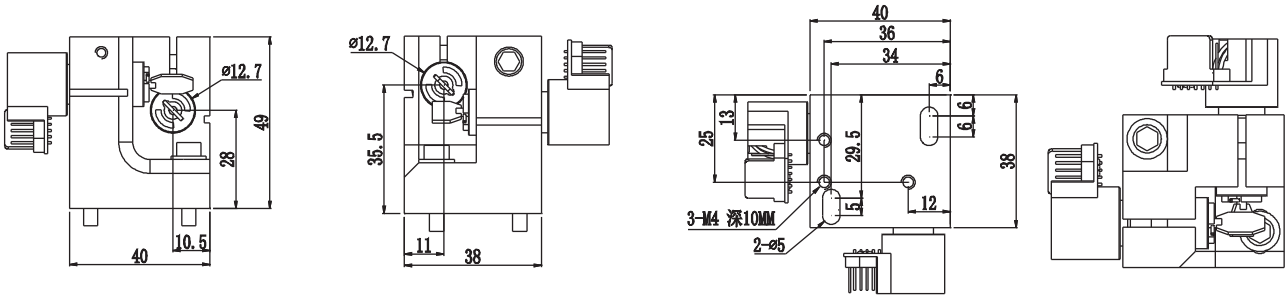

Galvos

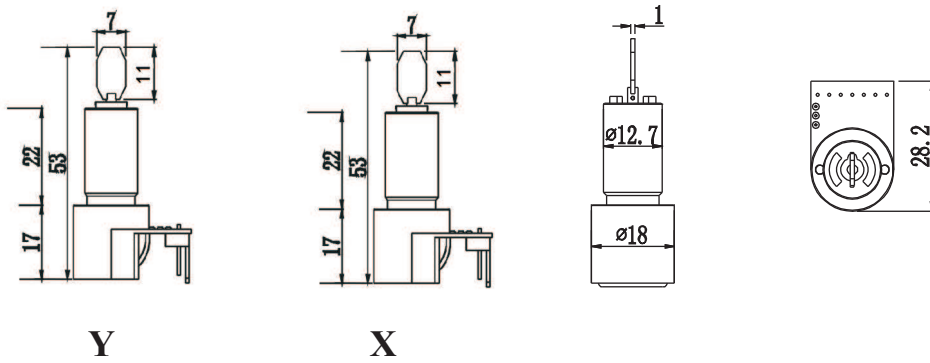

Driver Board

